



SIMULATION

Opération EBOLA

INTERVENTIONS COMMUNAUTAIRES

1/ Imprimer les fiches

La face A au Recto et la Face B au Verso pour les fiches à deux côtés.

Imprimer toutes les fiches ou uniquement celles que vous avez besoin. Ce recueil de fiches contient tous les éléments dont vous avez besoin mais vous pouvez les imprimer en plusieurs exemplaires en fonction de vos besoins.

2/ Découper les éléments en suivant les contours en pointillés

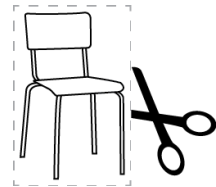

PERSONNAGES

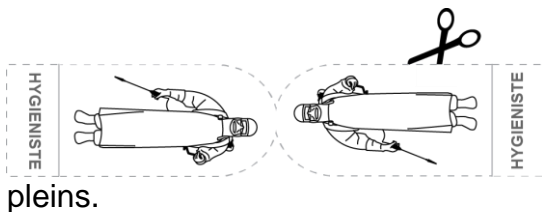

A) Découper chaque personnage en suivant les contours en pointillés sans couper entre les deux faces. Ne pas découper le long des traits pleins.

B) Plier le modèle de personnage en son milieu en rabattant chaque face de façon à ce que la pliure se retrouve en haut du modèle.

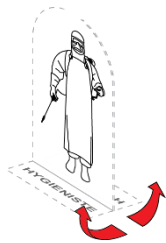
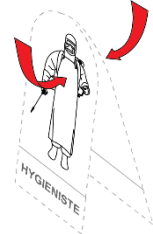

C) Plier au niveau du trait plein la base de chaque face à 90° afin de créer le socle qui maintiendra le personnage en position verticale.

D) Appliquer un morceau de bande adhésive transparente autour du personnage afin de coller les deux faces ensemble et de le protéger lors des manipulations futures.







E) Facultatif : vous pouvez également coller un morceau de bande adhésive sur le dessus du support afin de renforcer la base.

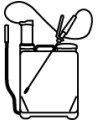

ELEMENTS SPECIAUX

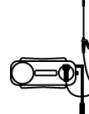
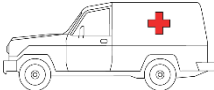
Certains éléments peuvent être utilisés de plusieurs façons :

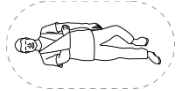
- **Les pulvérisateurs** stockage :  transport :  pulvérisation : 
- **Les véhicules** mouvement :  chargement : 
- **Les malades immobiles**  qui peuvent être utilisés comme décédés

Croix-Rouge française
98 rue Didot, 75694 Paris Cedex 14 FRANCE
Tel : +33 (0)1 44 43 11 00
Créé et développé par Pixel Impact



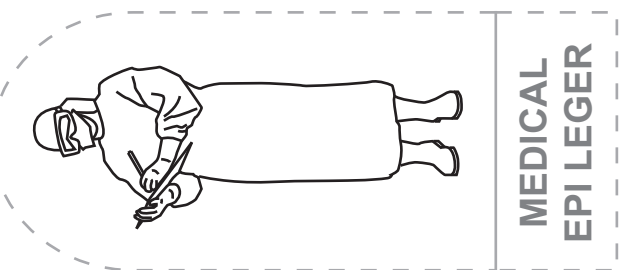
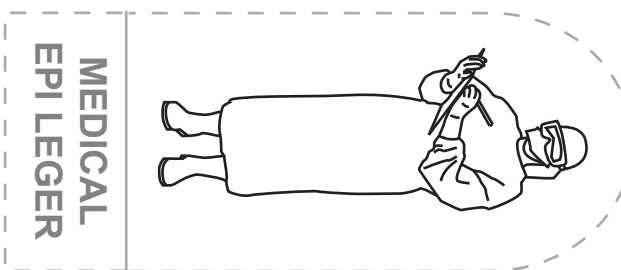
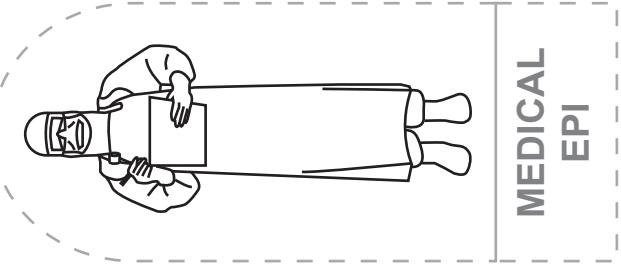
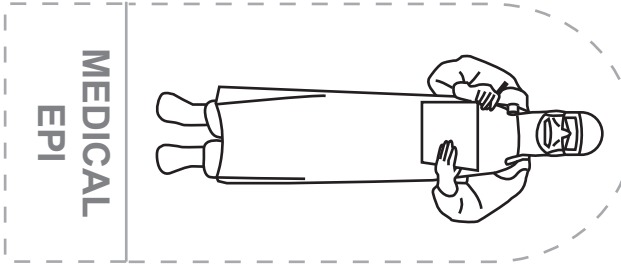
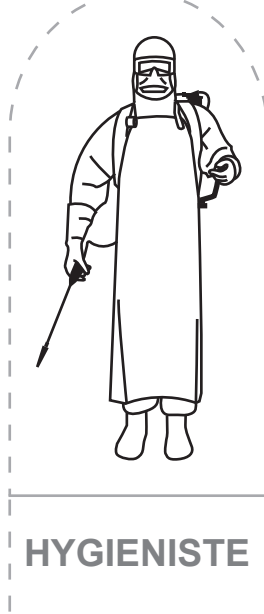
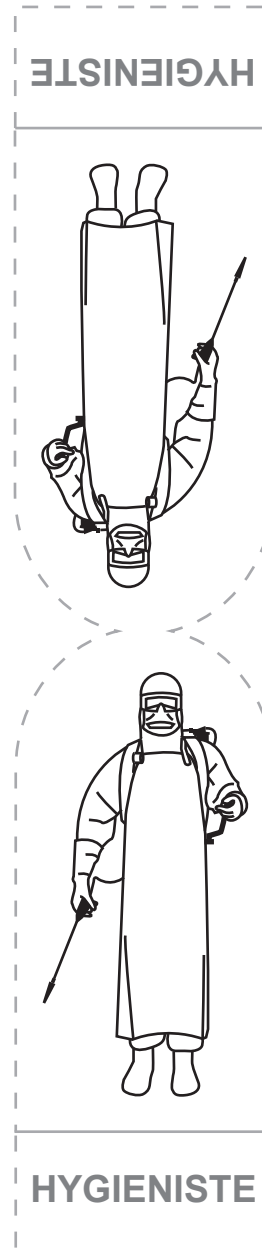
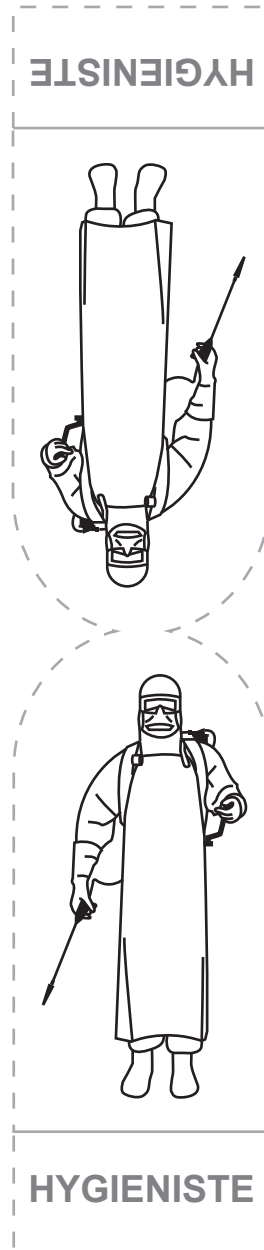
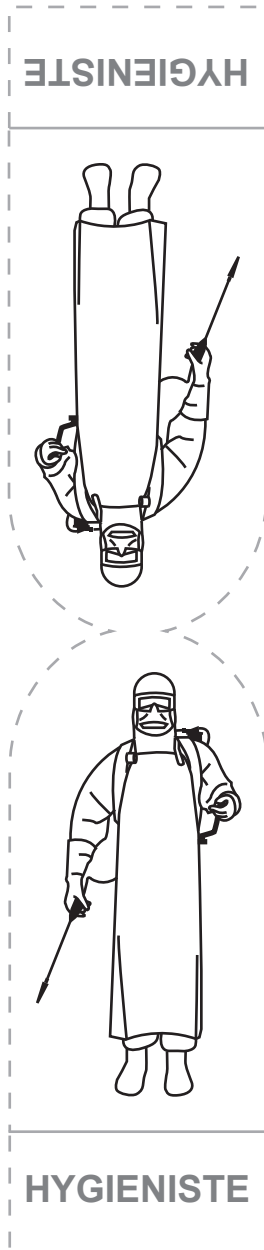
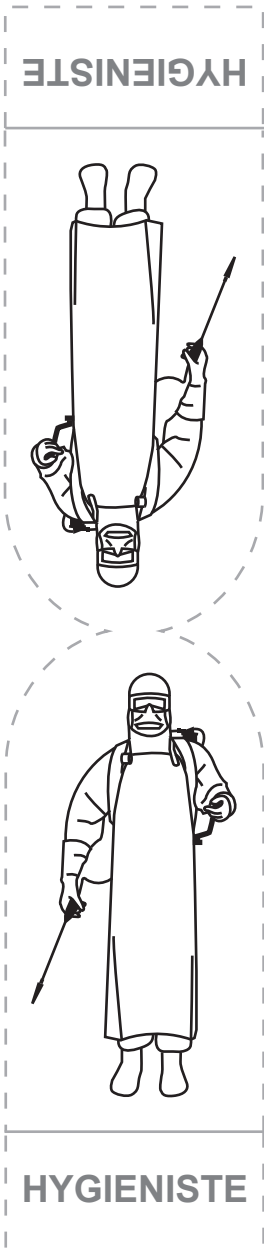

CHEF D'EQUIPE

CHEF D'EQUIPE

CHAUFFEUR

CHAUFFEUR

CHAUFFEUR

CHAUFFEUR

CHAUFFEUR

CHAUFFEUR

SENSIBILISATEUR

SENSIBILISATEUR

SENSIBILISATEUR

SENSIBILISATEUR

SENSIBILISATEUR

SENSIBILISATEUR

SENSIBILISATEUR

SENSIBILISATEUR

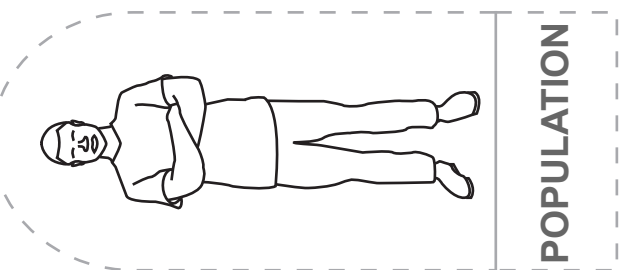
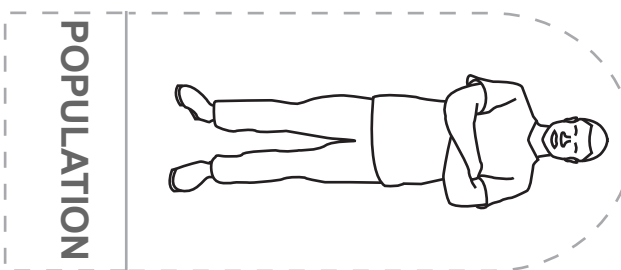
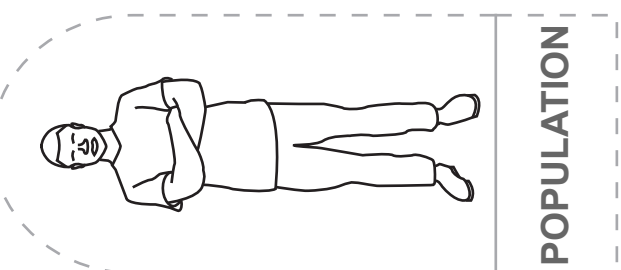
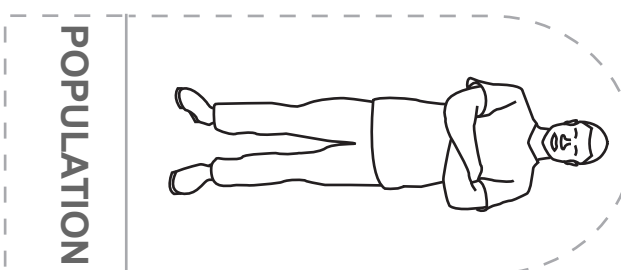
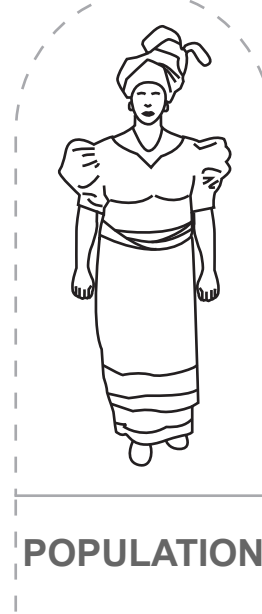
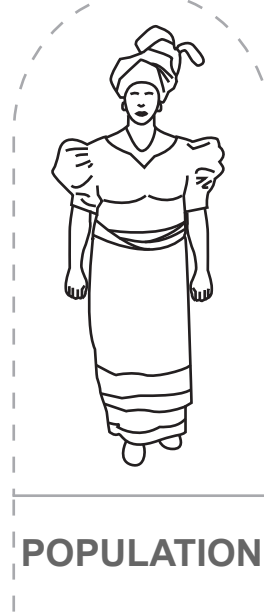
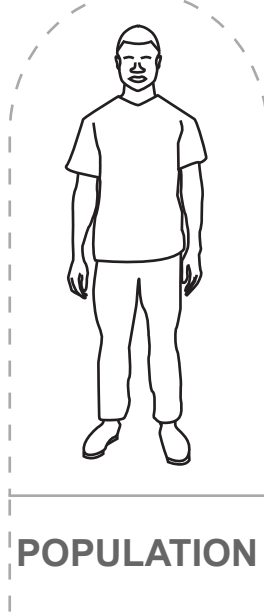
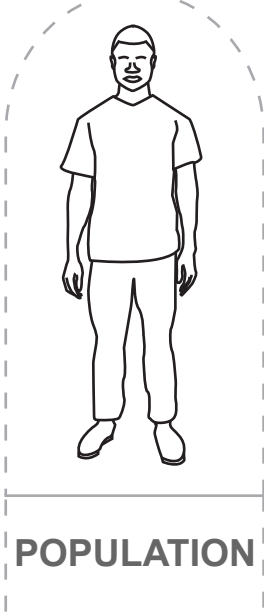
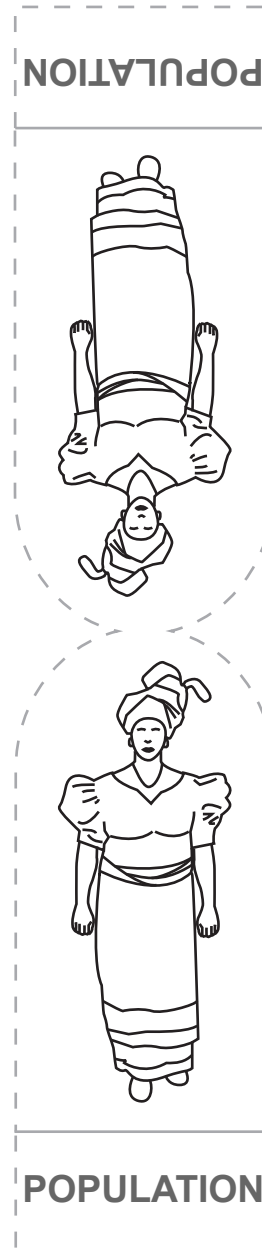
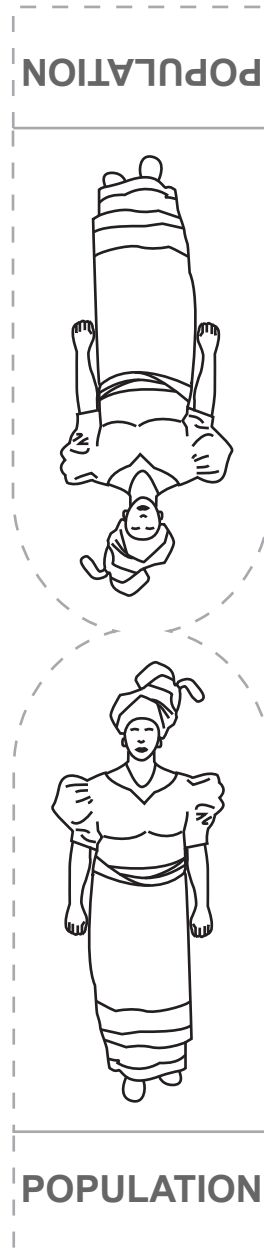
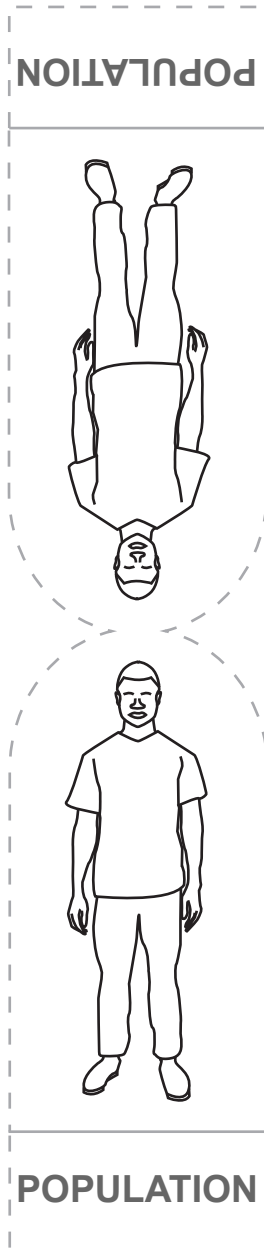
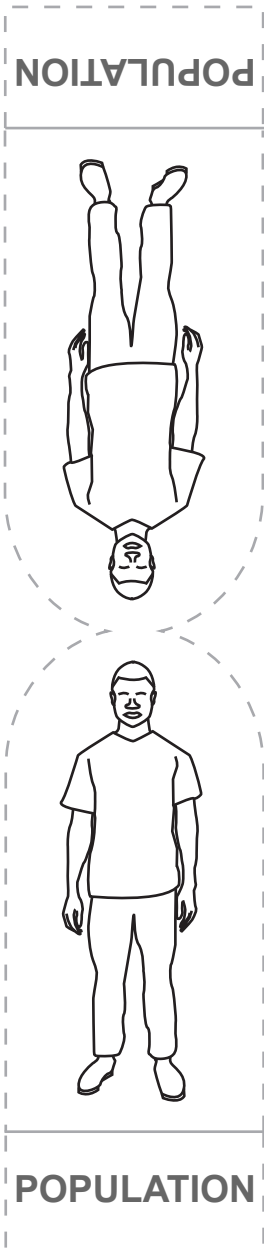

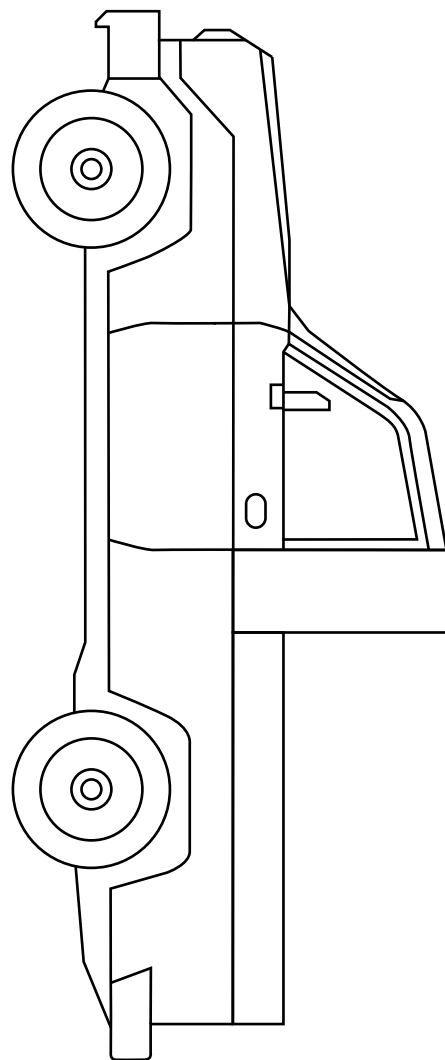
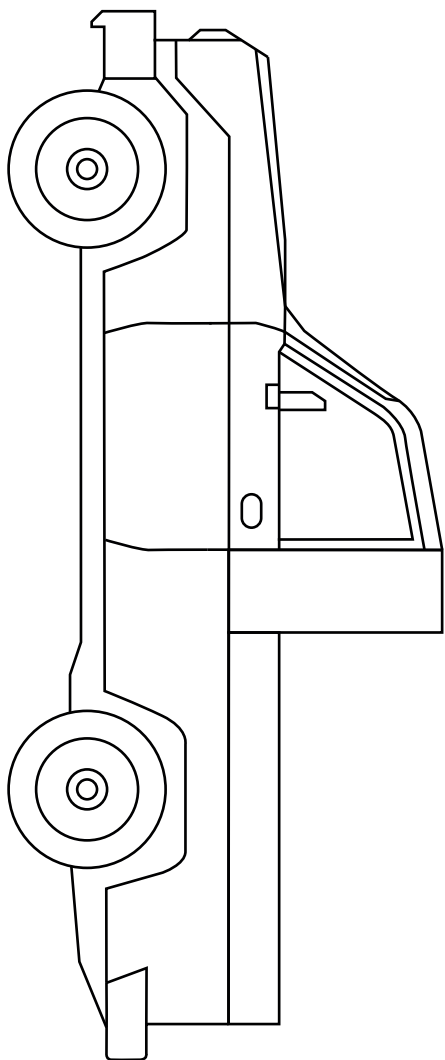
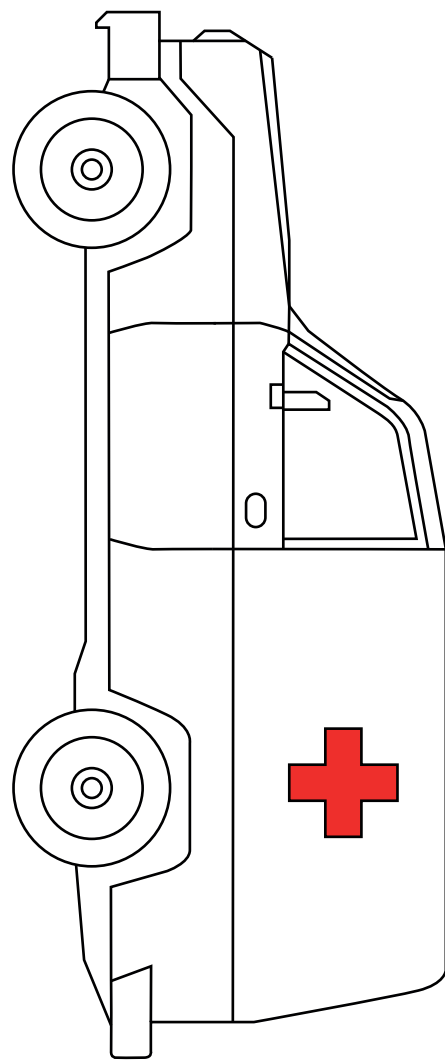
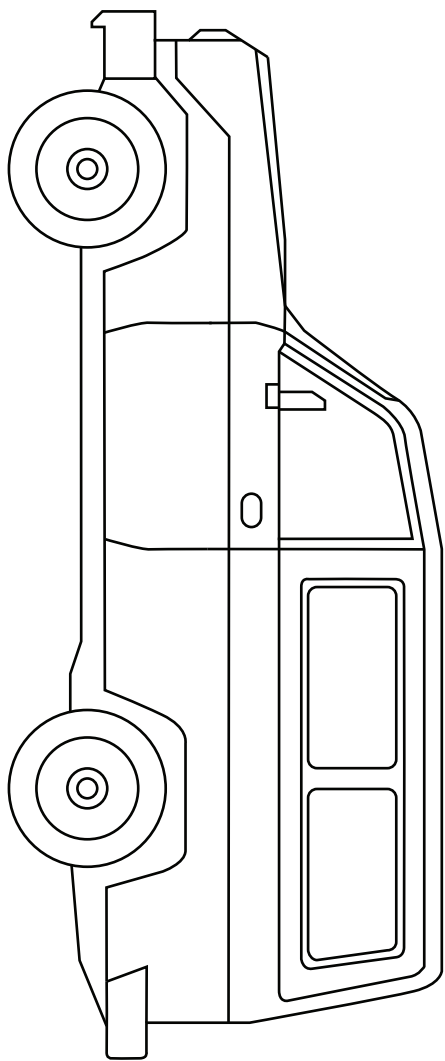

AMBULANCE

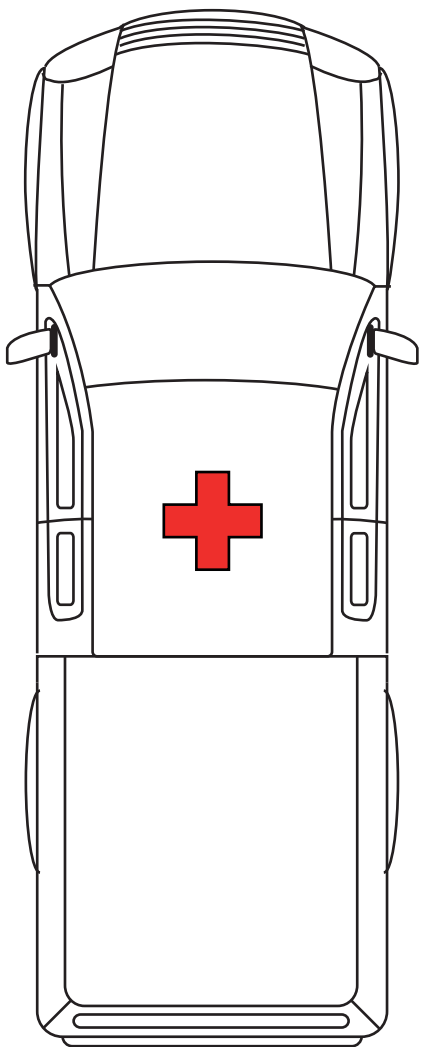

4x4

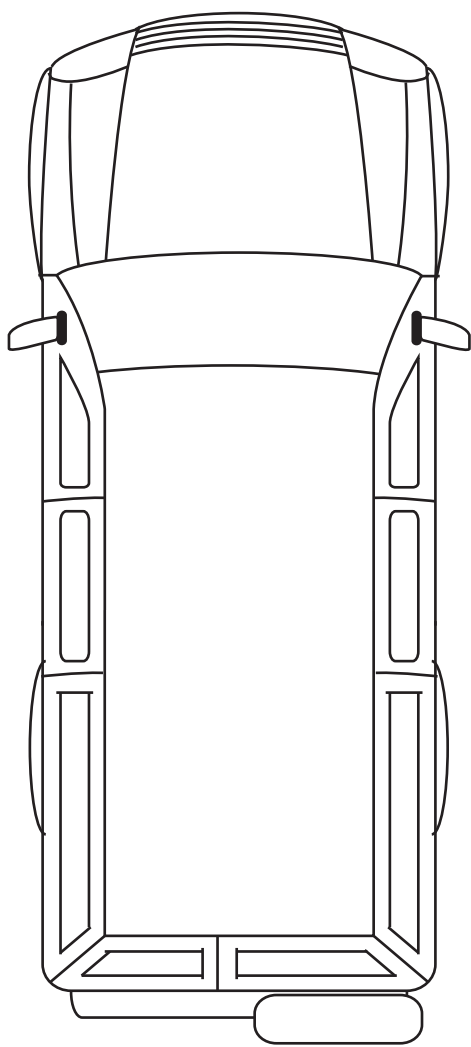

Pickup

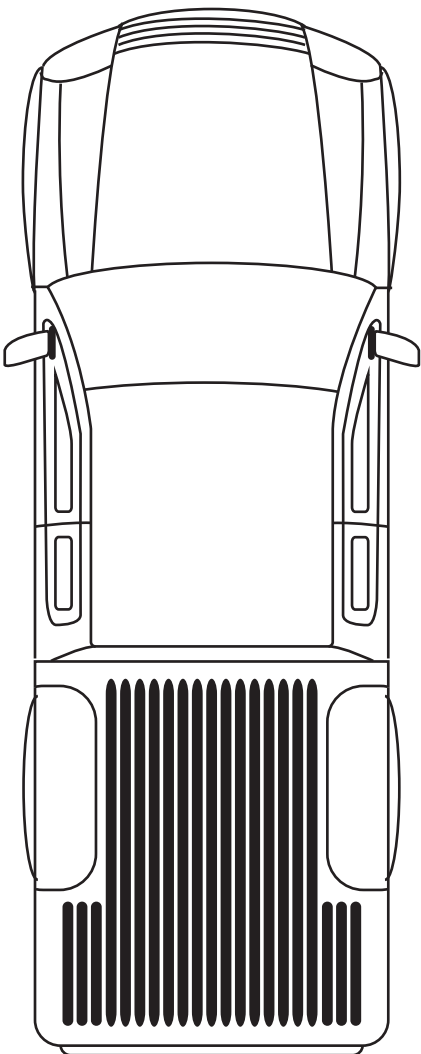

Pickup

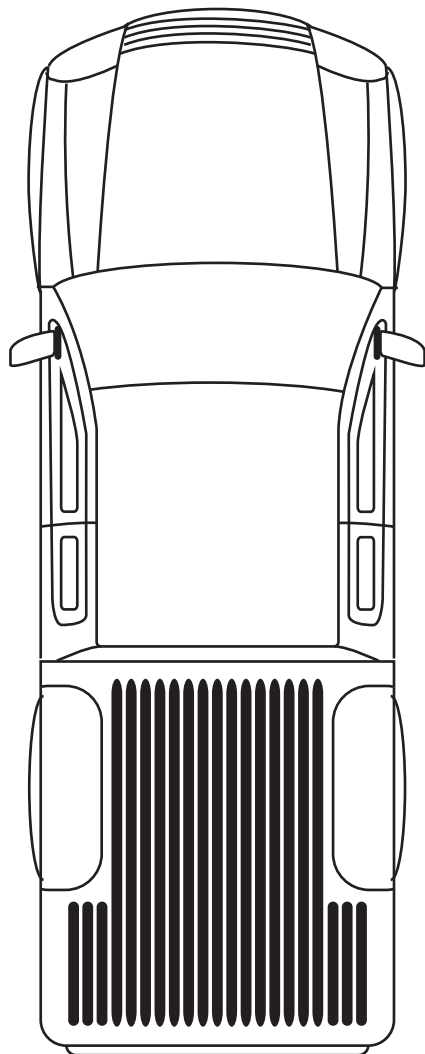

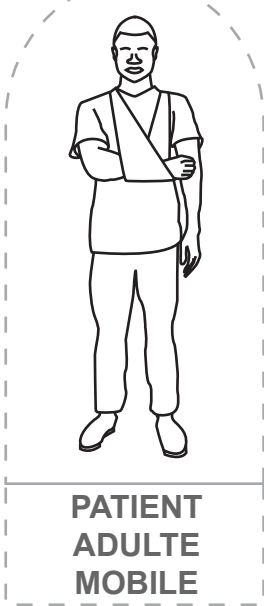
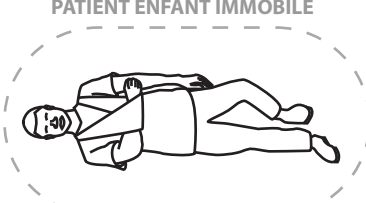
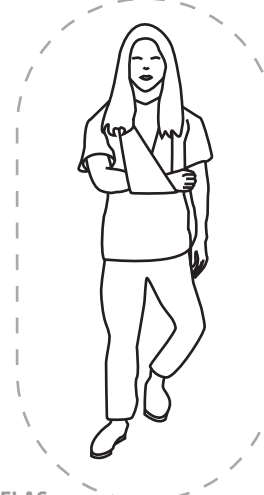
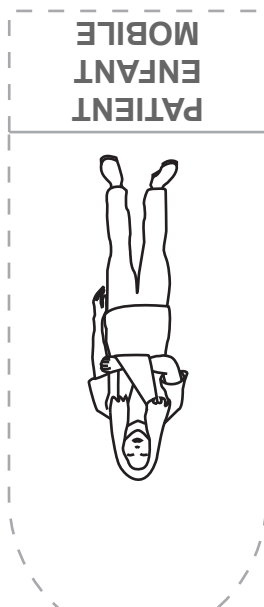
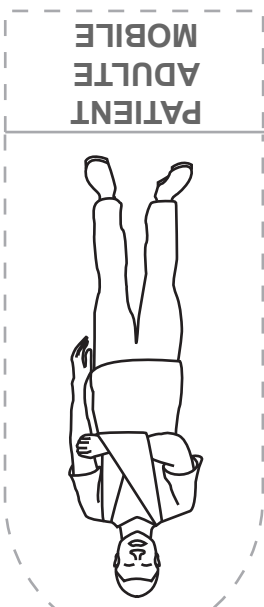

MATELAS

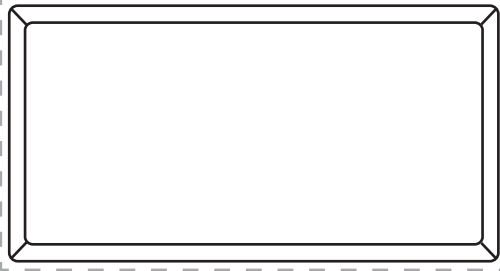
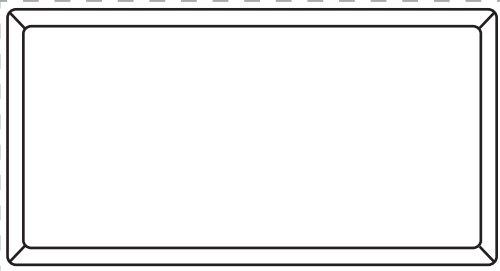

SAC MORTUAIRE - GRAND

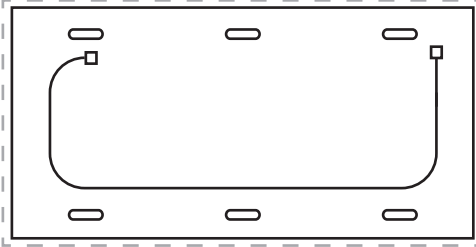

SAC MORTUAIRE PETIT

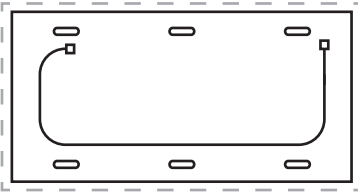

BRANCARD

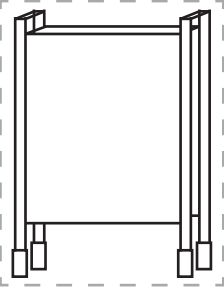
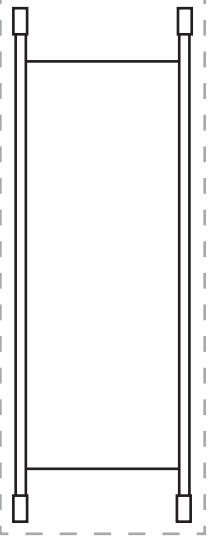

CHAIRES

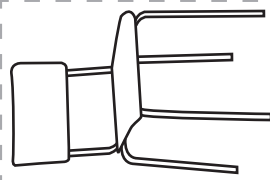
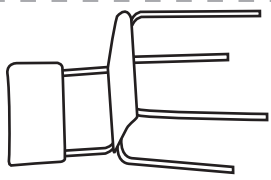
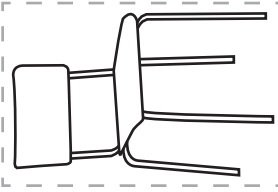
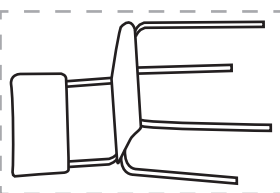

BACHES PLASTIQUE



TABLE

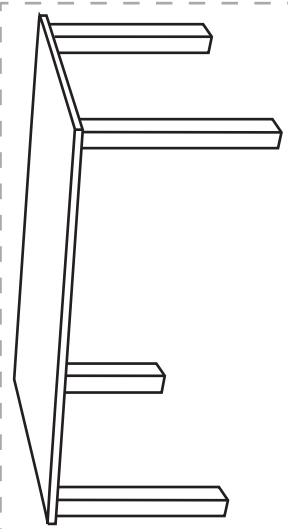

LIT

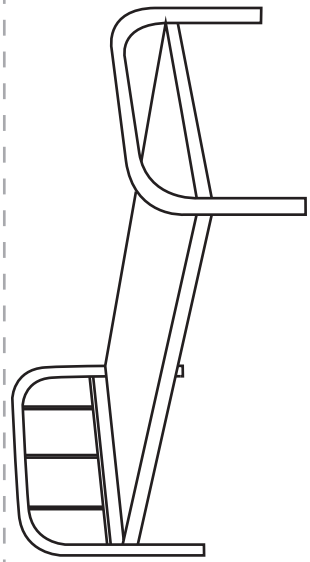

**PATIENT ENFANT
IMMOBILE**

**SAC MORTUAIRE
PETIT**

BRANCARD

BRANCARD

**BACHE
PLASTIQUE
1x1M**

**BACHE
PLASTIQUE
2x1.5M**

**PATIENT ADULTE
IMMOBILE**

MATELAS

MATELAS

**SAC MORTUAIRE
GRAND**

CHAISE

CHAISE

CHAISE

CHAISE

LIT

TABLE



SACS POUBELLE

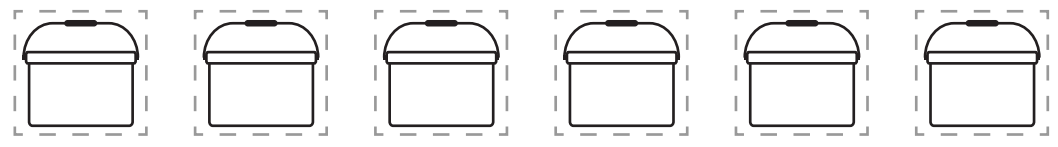

KITS



EAU & NOURRITURE

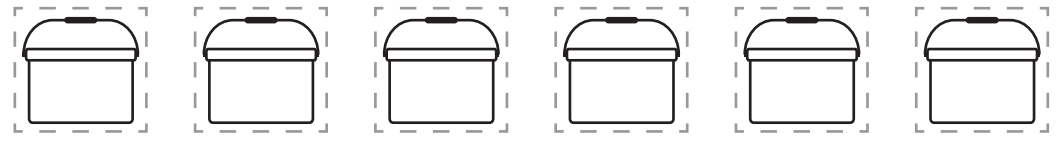

BIDONS 20L

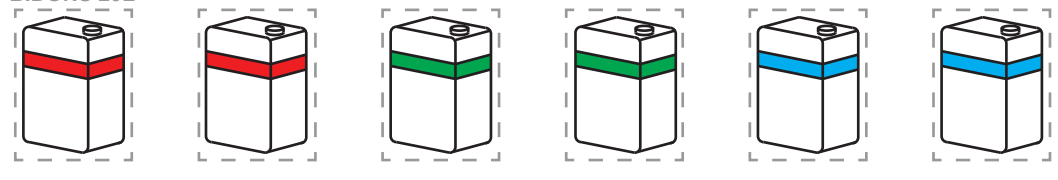

PULVERISATEURS 1L

CARBURANT

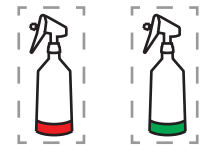

BASSINE 50L



PULVERISATEURS 12L

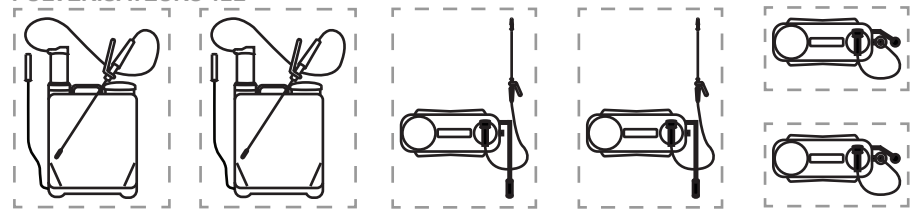

OBJETS

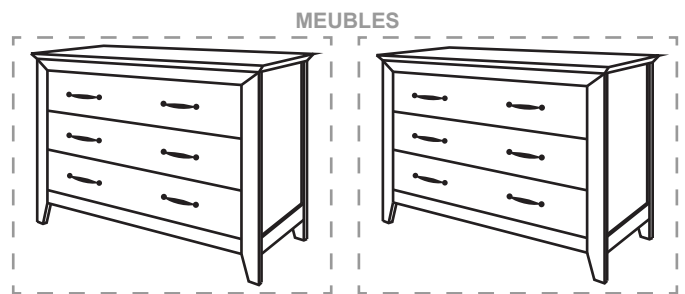

MEUBLES

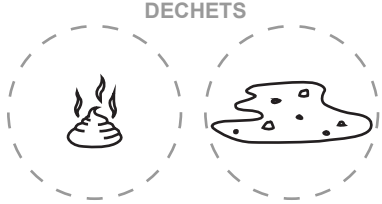

DECHETS



CHLORE



LATRINE

TISSUS

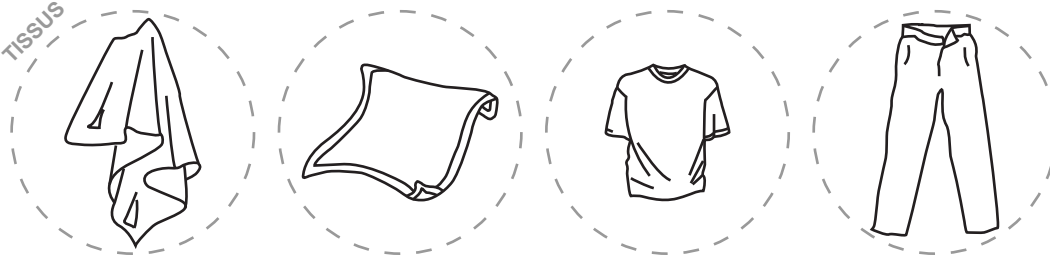

ANIMAUX

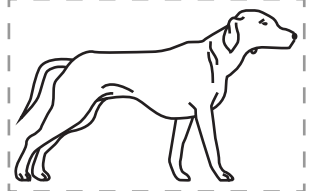

ARBRES

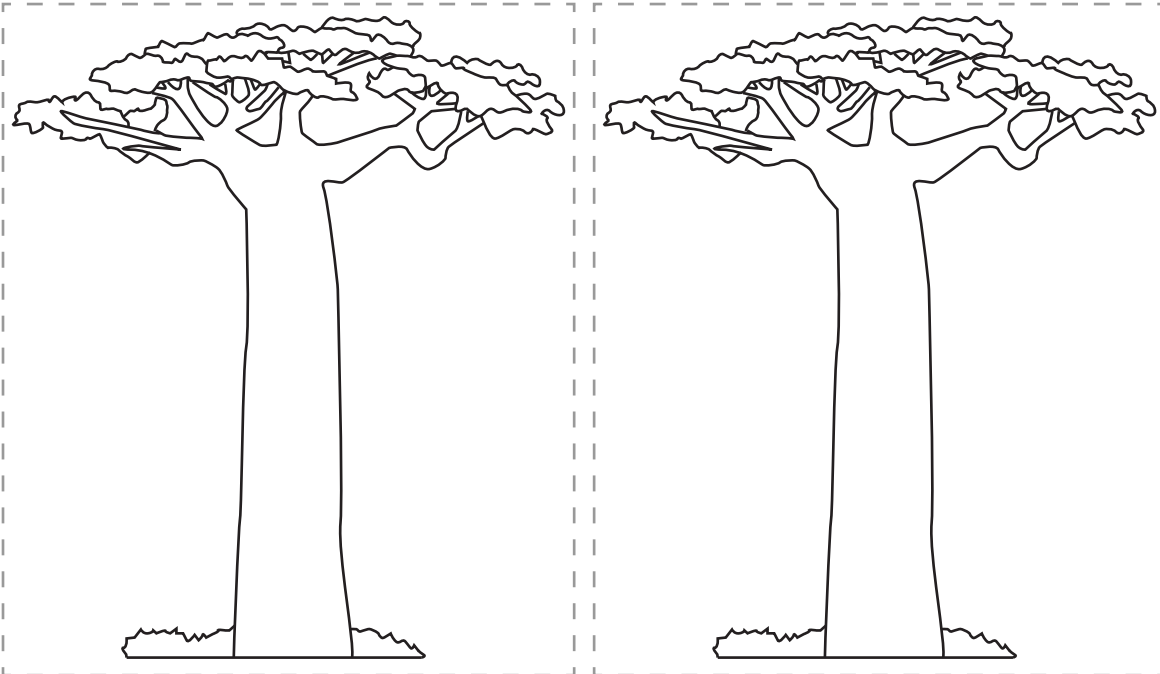

KIT
OUTREACH

KIT
OUTREACH

KIT
OUTREACH

KIT
OUTREACH

KIT
OUTREACH

KIT
OUTREACH

SAC
POUBELLE

SAC
POUBELLE

KIT
CONSULTATION

KIT
EXPOSITION
ACCIDENTELLE

KIT
COMPLEMENTAIRE

KIT
SOLIDARITE

KIT
SOLIDARITE

KIT

SAC
POUBELLE

SAC
POUBELLE

BIDON
20L
EAU

BIDON
20L
EAU

BIDON
20L
0,05%

BIDON
20L
0,05%

BIDON
20L
0,5%

BIDON
20L
0,5%

NOURRITURE

EAU

PULVERISATEUR
12L

PULVERISATEUR
12L

PULVERISATEUR
12L

PULVERISATEUR
12L

PULVERISATEUR
12L

BASSINE
50L

CARBURANT

PULVERISATEUR
1L
0,05%

PULVERISATEUR
1L
0,5%

PULVERISATEUR
12L

OBJETS
DIVERS

OBJETS
DIVERS

OBJETS
DIVERS

OBJETS
DIVERS

MEUBLE

MEUBLE

CHLORE

DECHETS

DECHETS

TISSUS
SOUILLES

TISSUS
SOUILLES

TISSUS
SOUILLES

TISSUS
SOUILLES

LATRINE

ANIMAL

ARBRE

ARBRE

ANIMAL

ANIMAL

ANIMAL

MAISONS

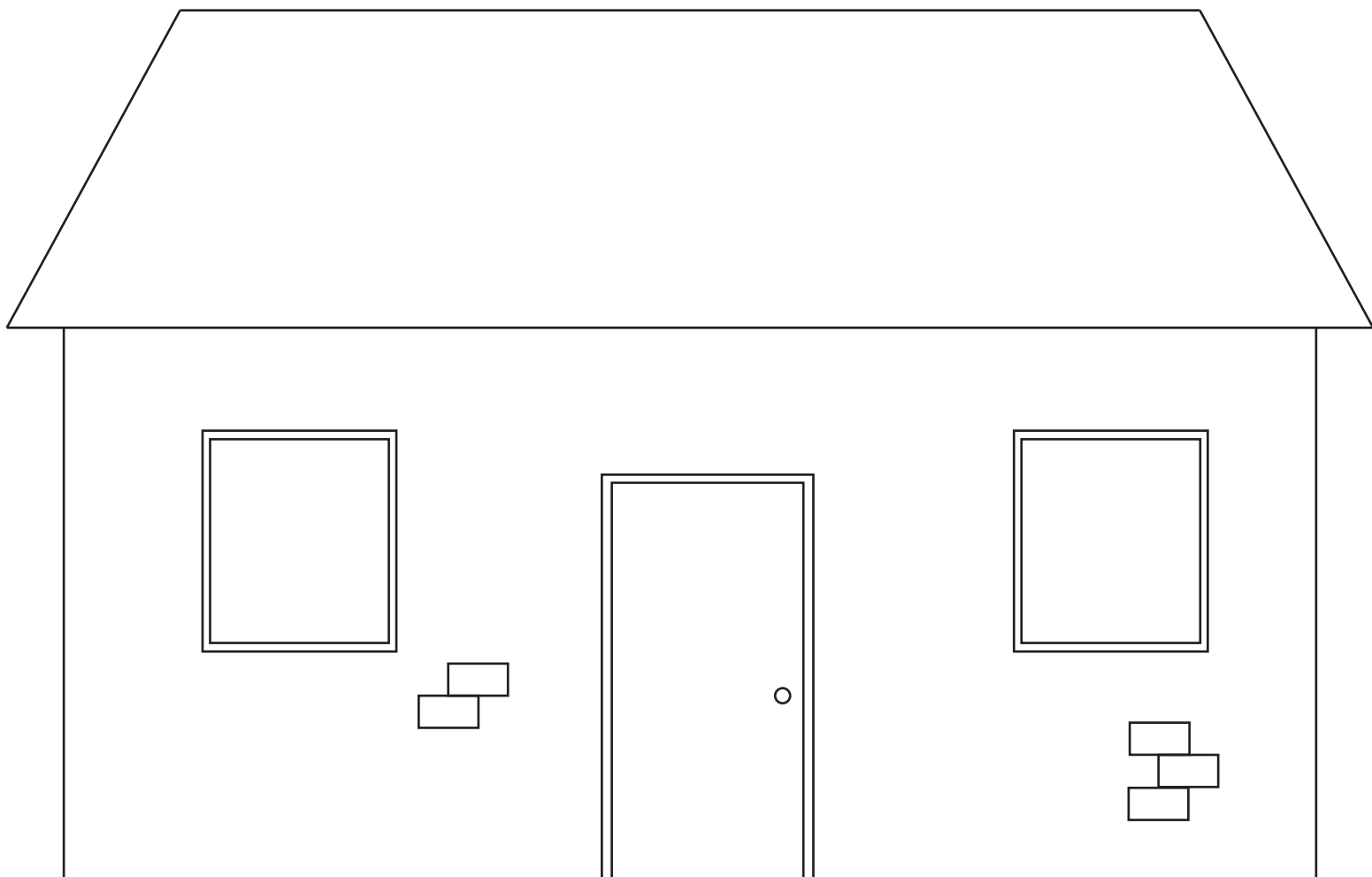
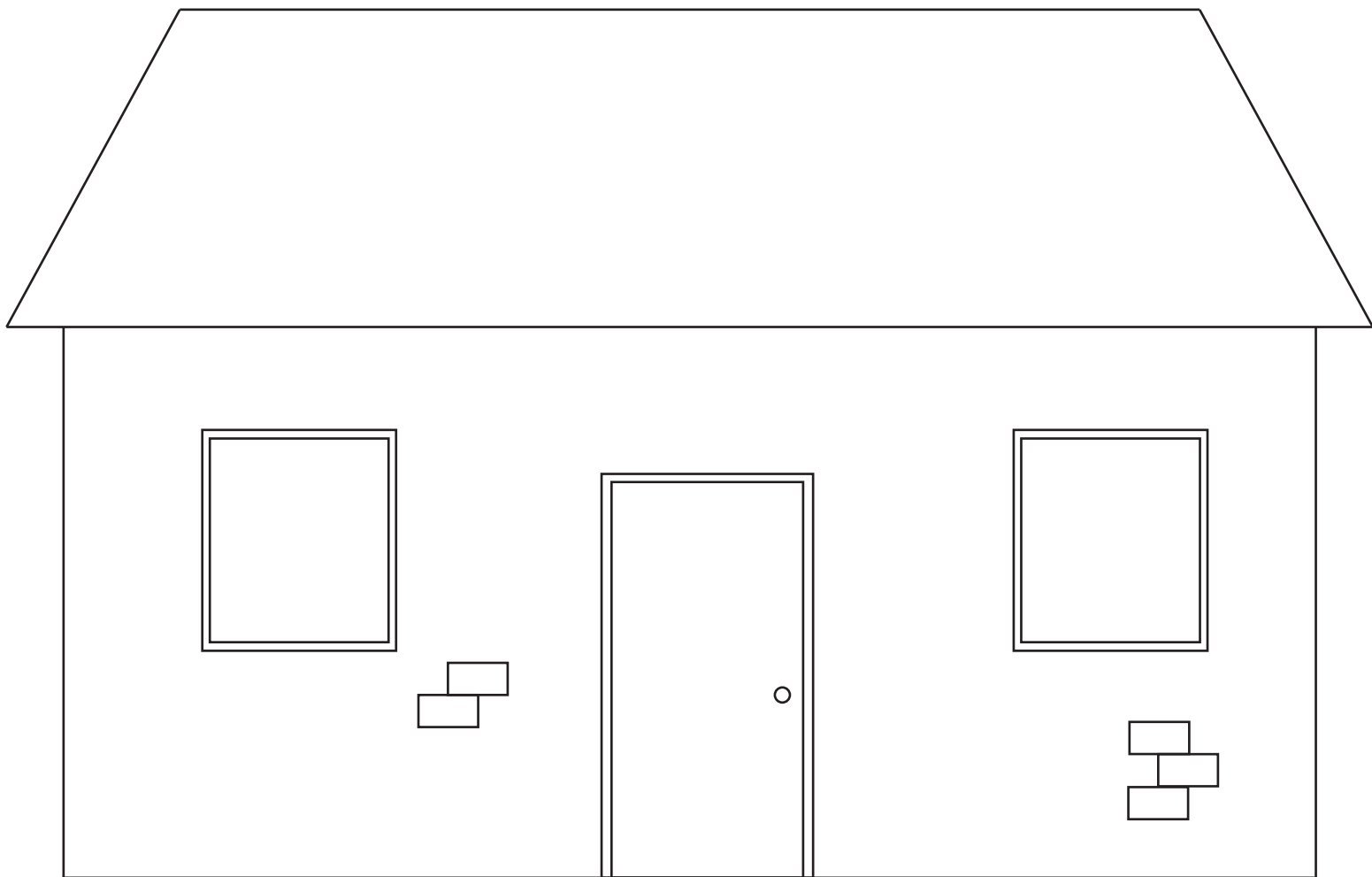

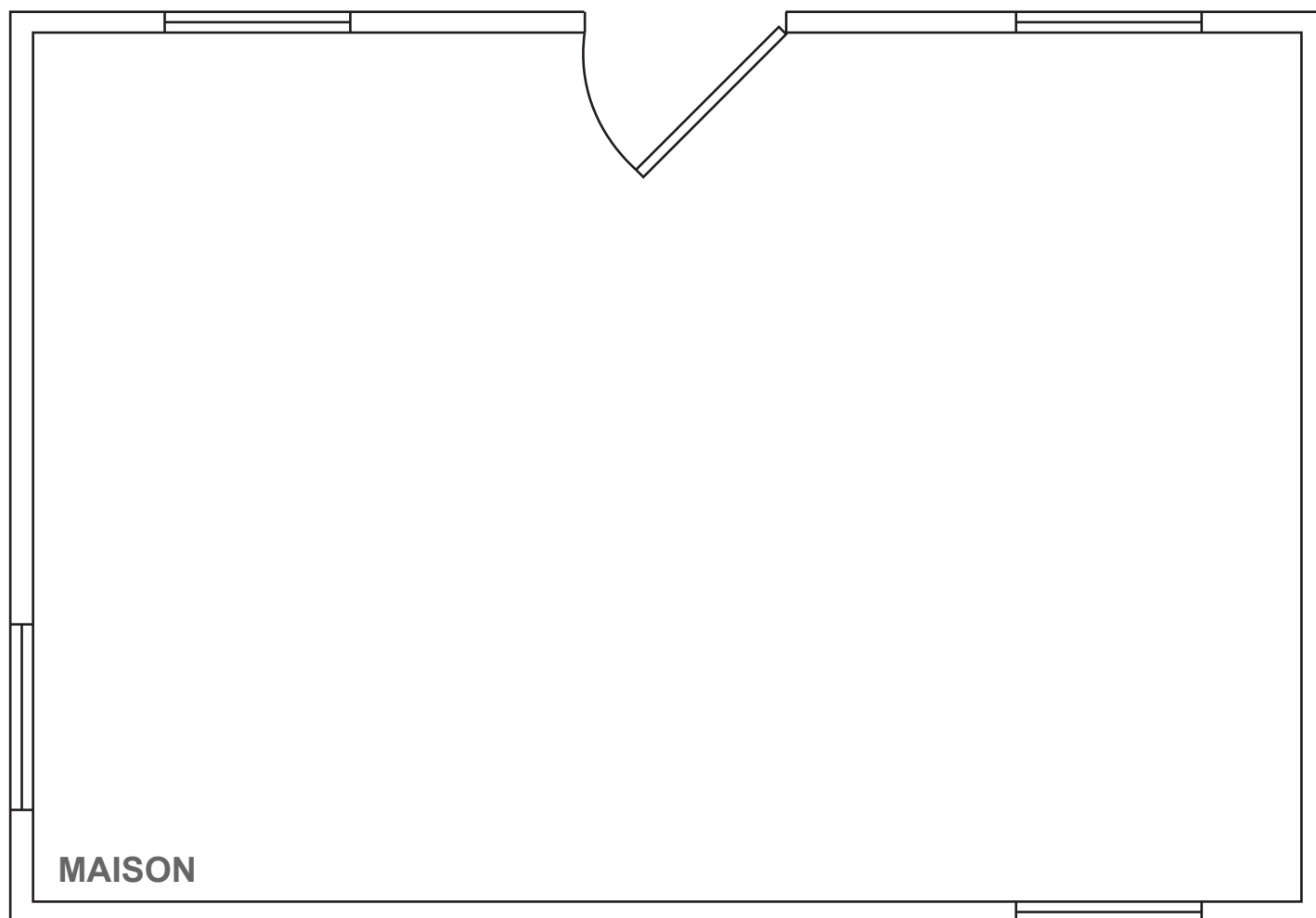
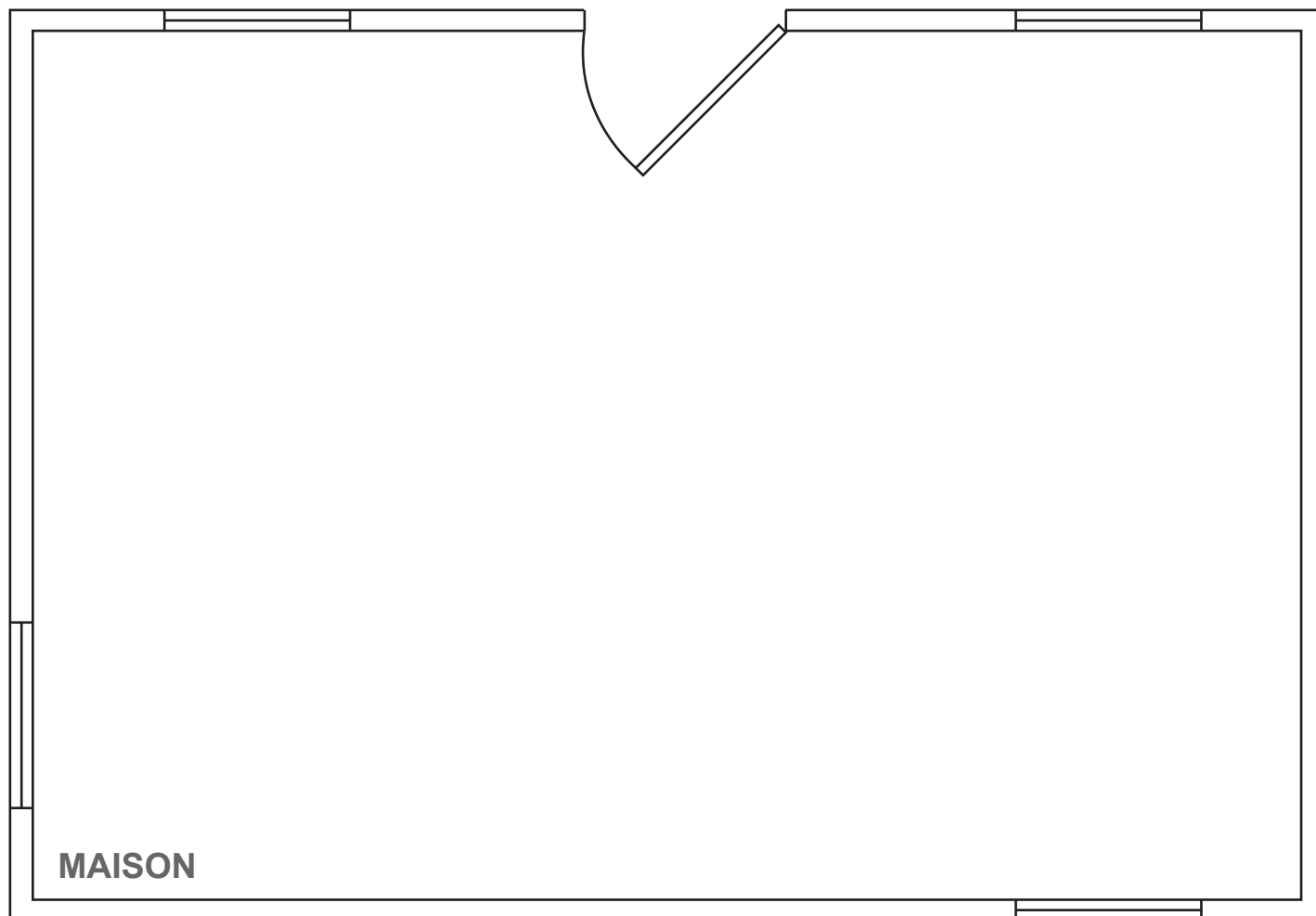

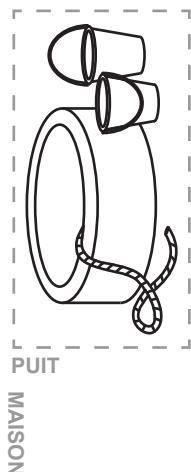
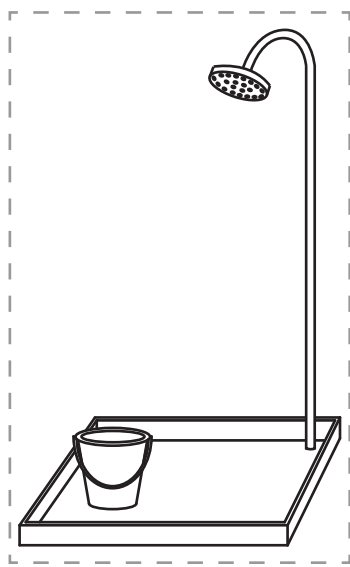
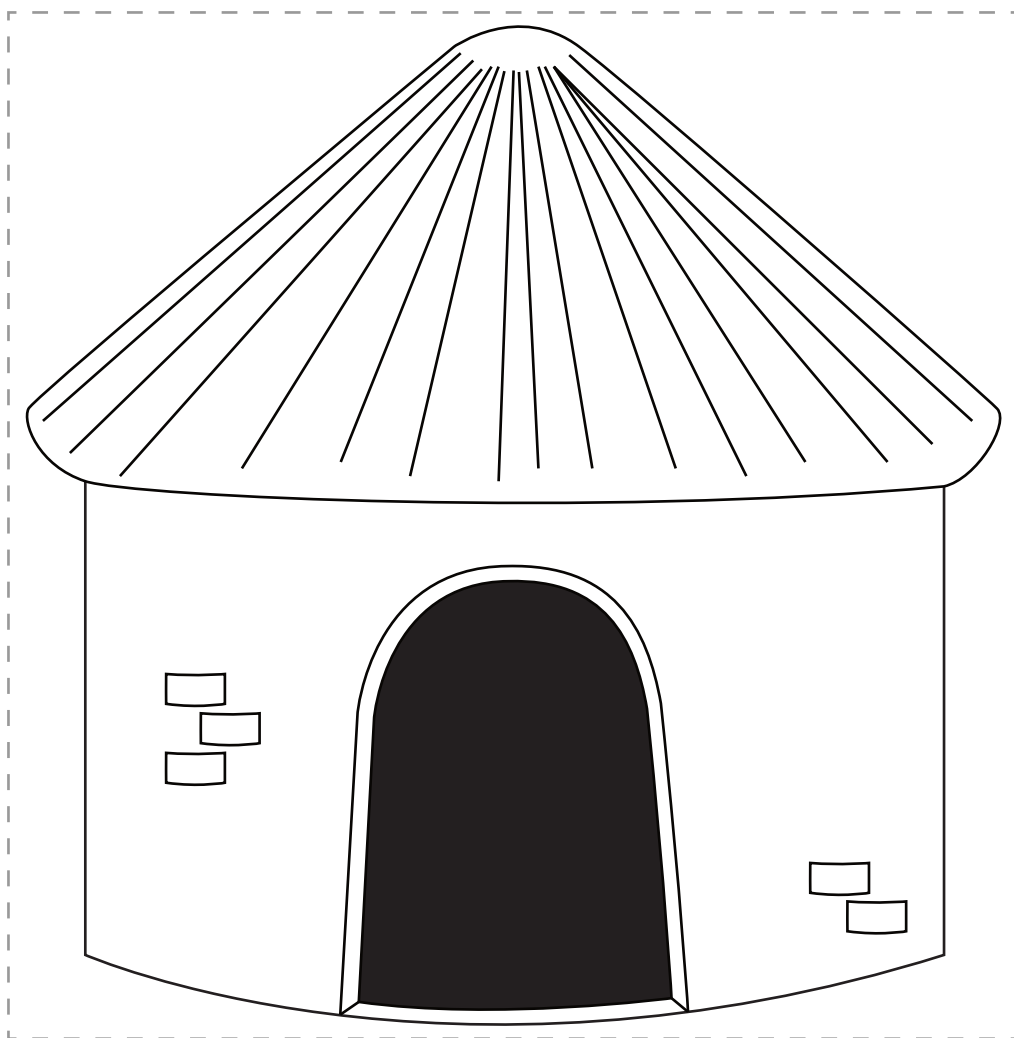

MATERIEL INDIVIDUEL

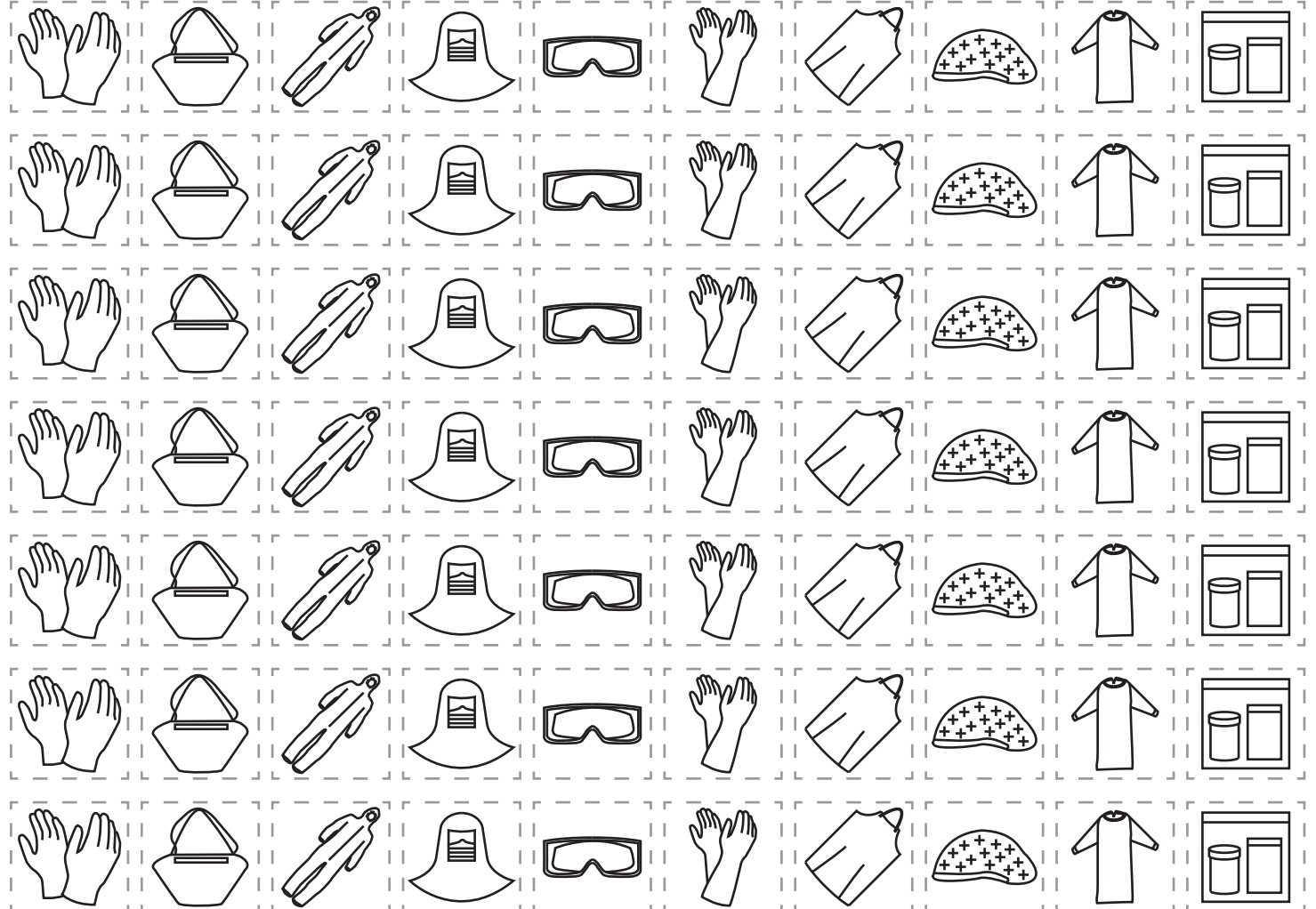

DOUCHE

FEU

EAU

PUIT

MAISON

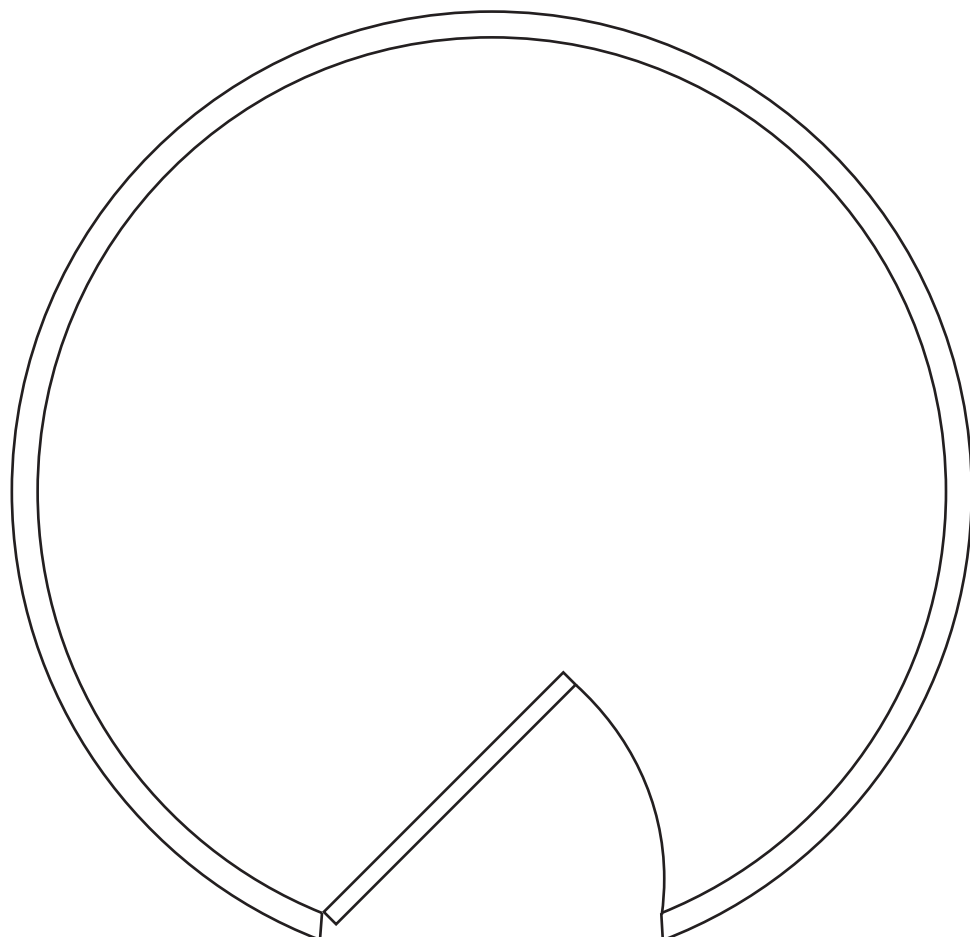

- KIT SWAB
- CASAQUE
- CHARLOTTE
- TABLIER
- GANTS PROTECTION
- LUNETTES
- CAGOULE
- EPI
- MASQUE
- GANTS
- KIT SWAB
- CASAQUE
- CHARLOTTE
- TABLIER
- GANTS PROTECTION
- LUNETTES
- CAGOULE
- EPI
- MASQUE
- GANTS
- KIT SWAB
- CASAQUE
- CHARLOTTE
- TABLIER
- GANTS PROTECTION
- LUNETTES
- CAGOULE
- EPI
- MASQUE
- GANTS
- KIT SWAB
- CASAQUE
- CHARLOTTE
- TABLIER
- GANTS PROTECTION
- LUNETTES
- CAGOULE
- EPI
- MASQUE
- GANTS
- KIT SWAB
- CASAQUE
- CHARLOTTE
- TABLIER
- GANTS PROTECTION
- LUNETTES
- CAGOULE
- EPI
- MASQUE
- GANTS
- KIT SWAB
- CASAQUE
- CHARLOTTE
- TABLIER
- GANTS PROTECTION
- LUNETTES
- CAGOULE
- EPI
- MASQUE
- GANTS
- KIT SWAB
- CASAQUE
- CHARLOTTE
- TABLIER
- GANTS PROTECTION
- LUNETTES
- CAGOULE
- EPI
- MASQUE
- GANTS